



e07-TD

**Evolution Series  
Technical Characteristics**

- Premium efficient motor
- High efficiency impeller
- Mountable in any position
- Maintenance free operation
- TEFC (IP55)

**Optional Features**

- Anodized aluminum components for corrosion resistance
- Increased sealing

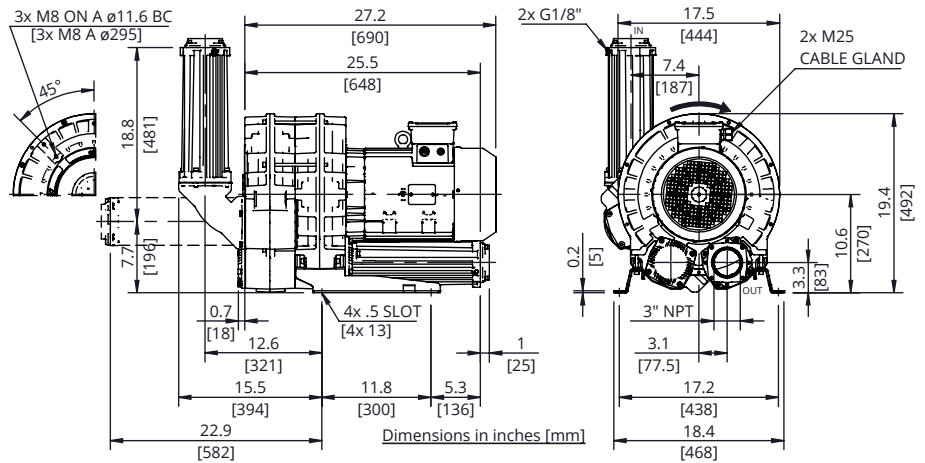

**Technical Specifications**

Model No.	HP	Hz	Open Flow (cfm)	Max Pressure in. H <sub>2</sub> O	Max Vacuum in. H <sub>2</sub> O	Efficiency	Voltage	FLA	Starting Current Ratio <sup>1</sup>	dB(A) <sup>2</sup>	Weight (lb)
SCL e07-TD-15-3	15	60	304	220	170	91.0%	208-230/460	38.2-37.3/18.7	12.5	77.0	262.3
		50	255	220	160	91.2%	200/400	43.4/21.7		74.0	
SCL e07-TD-15-3-575	15	60	304	220	170	91.0%	575	13.9	11	77.0	262.3

Motors include normally closed thermal protector, 1.15 S.F. (60 Hz), tropicalized, Class F (B) insulation, and are suitable for use with VFD (Contact FPZ for pneumatic and speed limits when used with a VFD).

<sup>1</sup>Starting current ratio x fla = starting current

<sup>2</sup>Noise level measured at a distance of 1 m with inlet and outlet ports piped in accordance to ISO 3744

Data is subject to change without notice.

**Recommended Accessories**

Description	Pressure Safety Valve	Vacuum Safety Valve	Pressure Filter	Vacuum Filter	Check Valve
Part Number	VRL6 <sup>3</sup>	VRL6 <sup>3</sup>	FS-235P-300	CT-235P-300C	CV30

<sup>3</sup>Valve selections are based on 60 Hz and standard air. Valves are supplied uncalibrated. Safety valves are easy to calibrate, but can be ordered with factory calibration.



### PRESSURE

### VACUUM

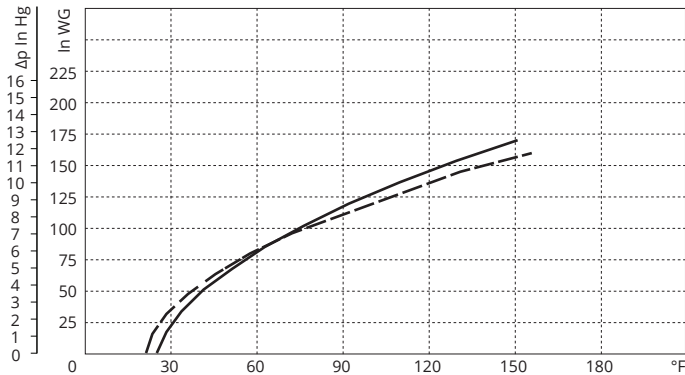
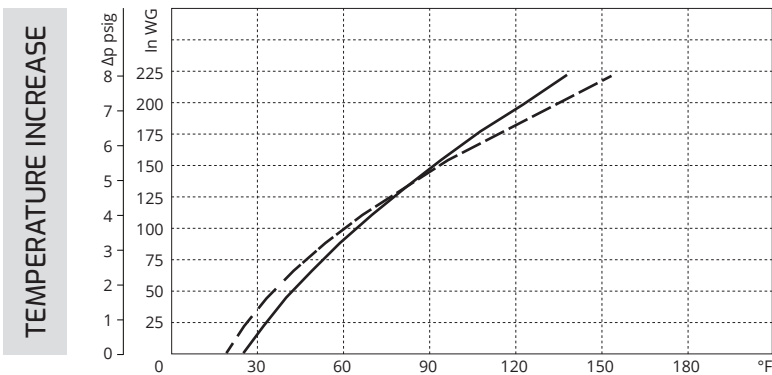
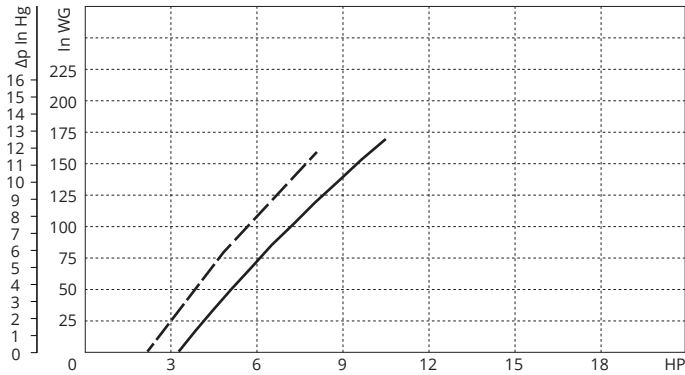
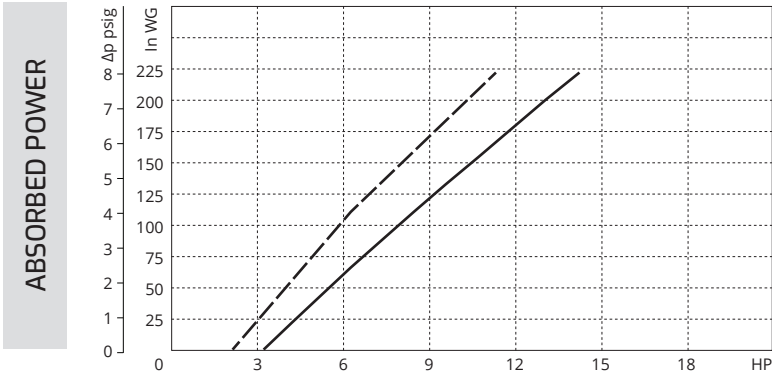
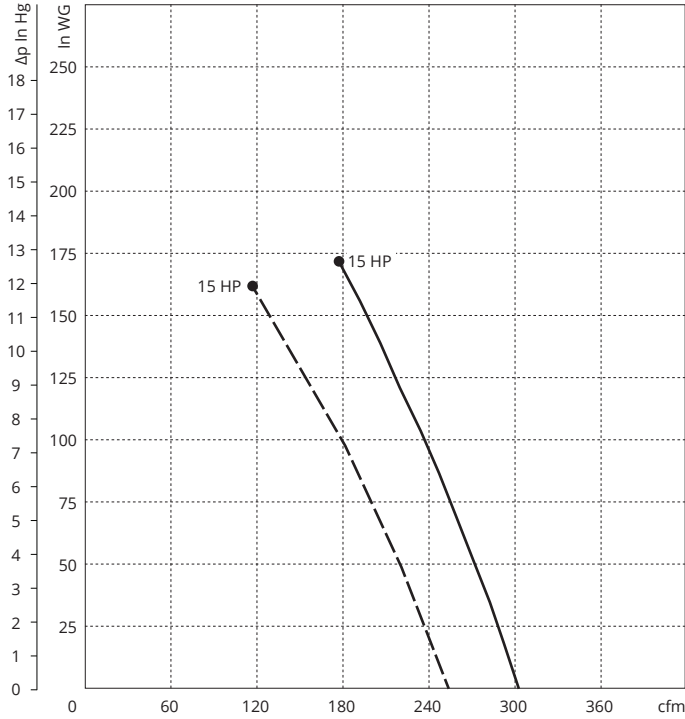
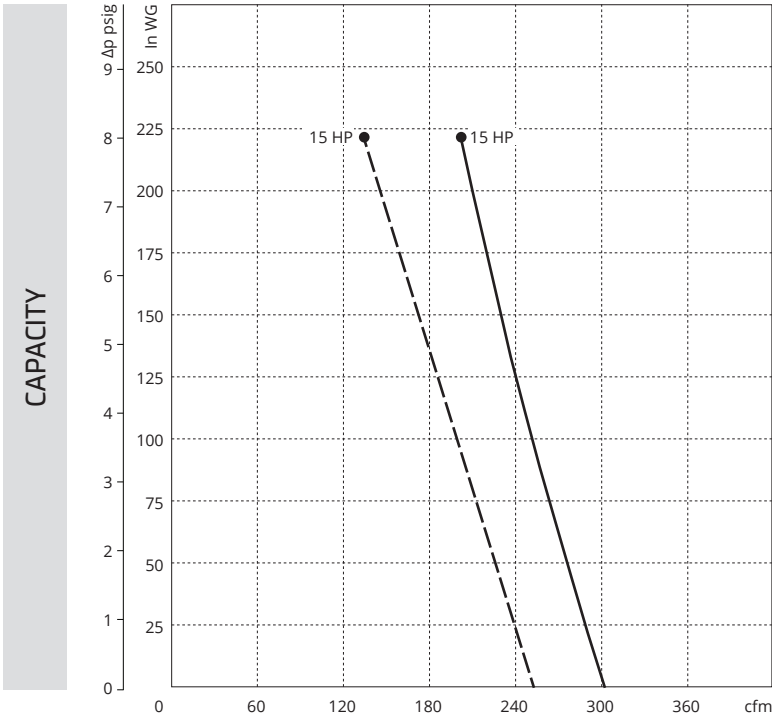

Curves refer to air at 68°F temperature and 29.92 In Hg atmospheric pressure (abs) measured at inlet port.  
 Values for flow, power consumption and temperature rise: +/-10% tolerance.  
 Data subject to change without notice.

**KEY**    --- 50 Hz  
 ——— 60 Hz