



TECHNICAL CHARACTERISTICS

- Aluminium alloy construction
- Smooth operation
- High efficiency impeller
- Maintenance free
- Mountable in any position
- Recognized TEFC-cURus motor
- G1/8" female thread on both suction and discharge silencer port flanges

OPTIONS

- Special voltages (IEC 38)
- Surface treatments

ACCESSORIES

- Inlet and/or inline filters
- Additional inlet/outlet silencers
- Safety valves
- Flow converting device
- Optional connectors

Dimensions in inches.
Dimension for reference only.

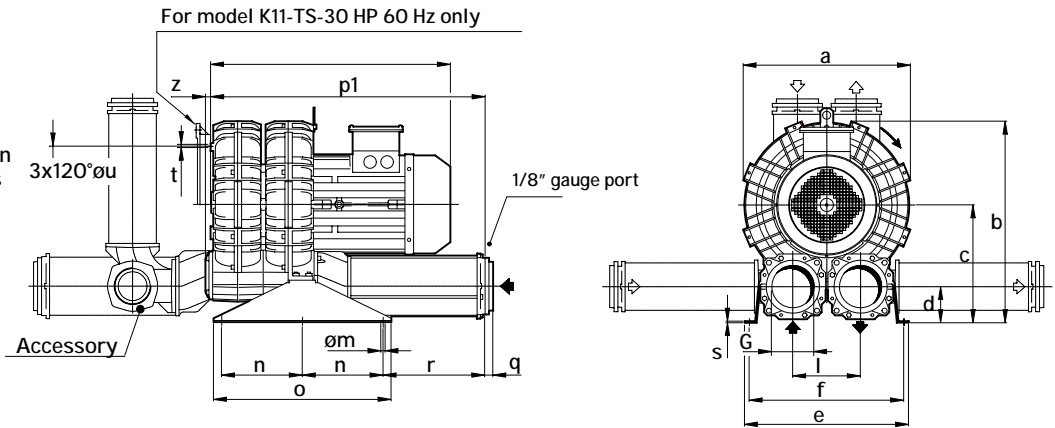

Model	a	b	c	d	e	f	G	l	m	n	o	p1	q	r	s	t	u	z
K07-TS	16.69	20.91	12.56	3.86	18.50	17.24	4" NPT	7.17	0.51	9.84	21.65	31.57	0.98	11.77	0.20	M8	11.61	0.63
K08-TS	17.99	21.57	12.56	3.86	18.90	17.64	4" NPT	7.17	0.51	9.84	21.65	31.57	0.98	11.77	0.20	M8	12.20	0.63
K09-TS	19.37	24.02	14.37	4.41	20.08	18.82	5" NPT	8.27	0.51	9.84	21.65	33.46	1.38	12.40	0.20	M8	14.17	0.63
K10-TS	20.31	24.53	14.37	4.41	20.08	18.82	5" NPT	8.27	0.51	9.84	21.65	33.46	1.38	12.40	0.20	M8	14.17	0.63
K11-TS	21.34	25.59	14.96	4.17	21.26	20.00	5" NPT	8.98	0.51	9.84	21.65	34.25	1.38	12.60	0.20	M8	15.35	0.63
K12-TS	21.57	25.71	14.96	4.17	21.26	20.00	5" NPT	8.98	0.51	9.84	21.65	34.8	1.38	12.60	0.20	M8	15.4	0.63

Model	Maximum flow cfm		Installed power Hp		Maximum diff erential pressure Δp (In Hg)		Noise level Lp dB (A) (1)		Overall dimensions H Inches	Weight Lbs
	60 Hz	50 Hz	60 Hz	50 Hz	60 Hz	50 Hz	60 Hz	50 Hz		
	3500 rpm	2900 rpm	3500 rpm	2900 rpm	3500 rpm	2900 rpm	3500 rpm	2900 rpm		
K07-TS	588	487	7 1/2	7 1/2	2.6	4.4	83.9	81.9	23.0	218.3
			10	10	4.4	6.6	84.2	82.2	24.5	230.4
			15	15	8.1	8.1	84.8	82.8	24.5	243.7
K08-TS	715	592	15	15	4.4	6.4	83.3	81.3	24.5	256.0
K09-TS	941	780	20	20	5.9	7.4	85.0	83.0	31.0	422.0
			25	25	8.1	8.8	87.0	85.0	31.0	432.0
K10-TS	1093	906	20	20	4.4	5.9	88.1	86.1	31.0	429.0
			25	25	5.9	7.4	88.4	86.4	31.0	439.0
K11-TS	1254	1039	25	25	3.4	6.6	89.4	87.4	31.5	469.0
			30	30	5.1	8.1	90.0	88.0	31.5	475.0
K12-TS	1410	1168	30	30	3.3	5.9	90.6	88.6	32.0	475.0

(1) Noise measured at 1 m distance with inlet and outlet ports piped, in accordance to ISO 3744.
 (2) K11-TS-30 HP vertical assembly only.

- For proper use, the blower should be equipped with inlet filter and safety valve; other accessories available on request.
- Ambient temperature from +5° to +104°F.
- Specifications subject to change without notice.



SCL K07 / K08 / K09 / K10 / K11 / K12

TS SERIES
SN 1826-16B

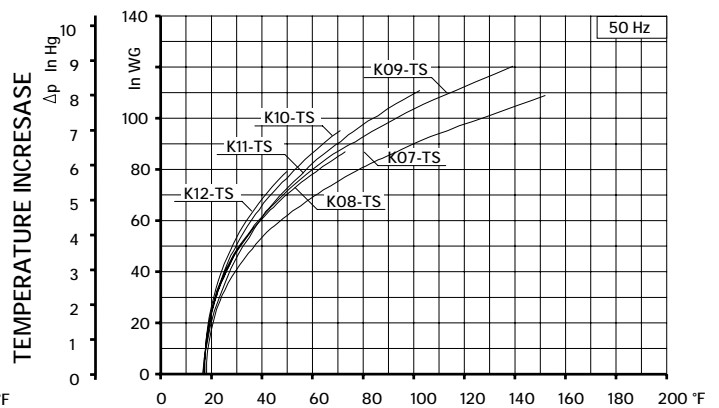
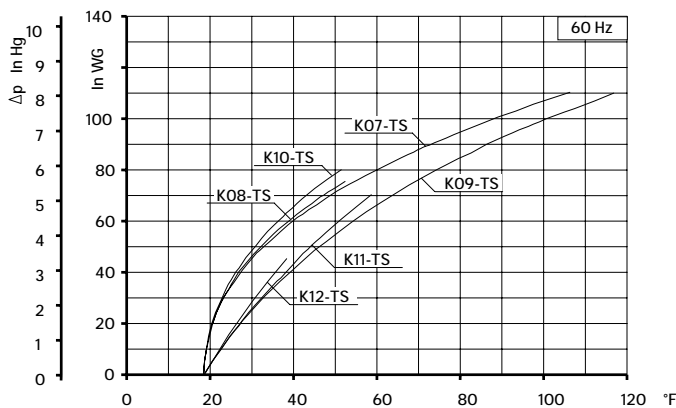
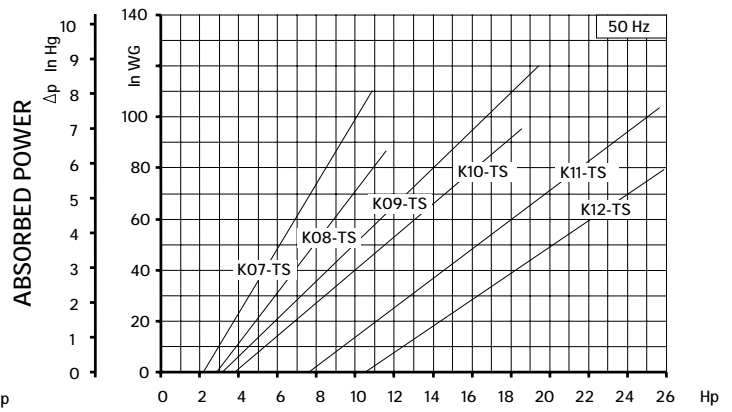
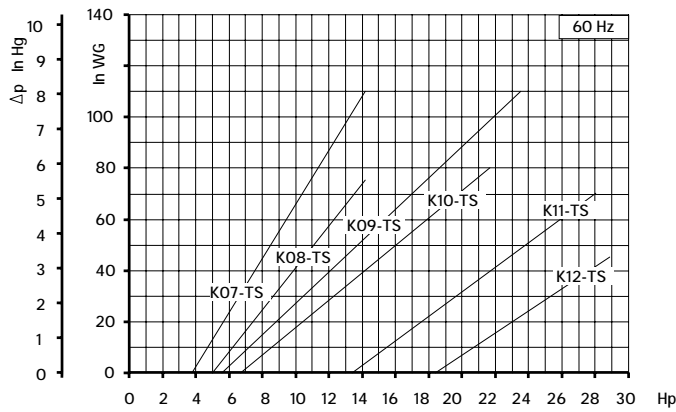
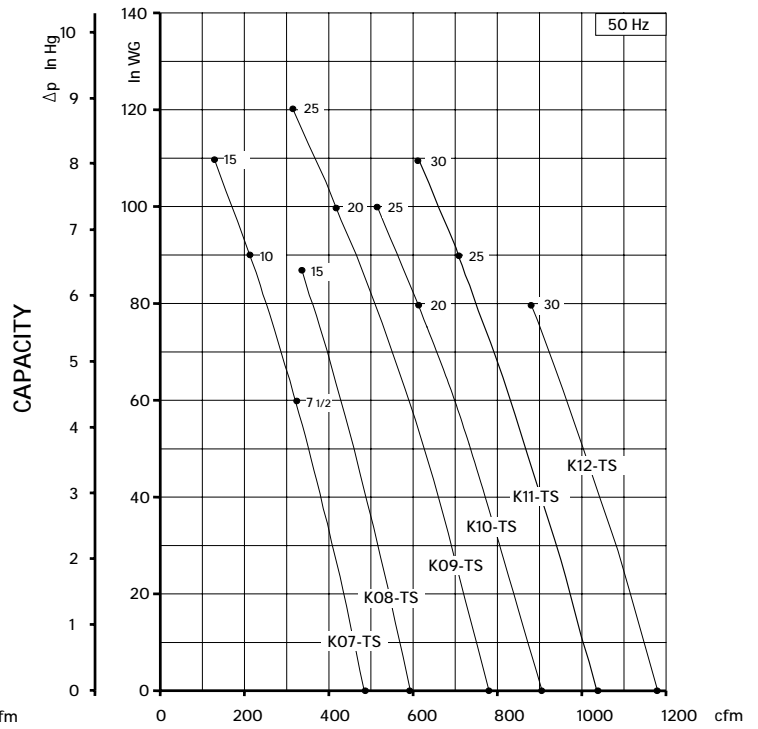
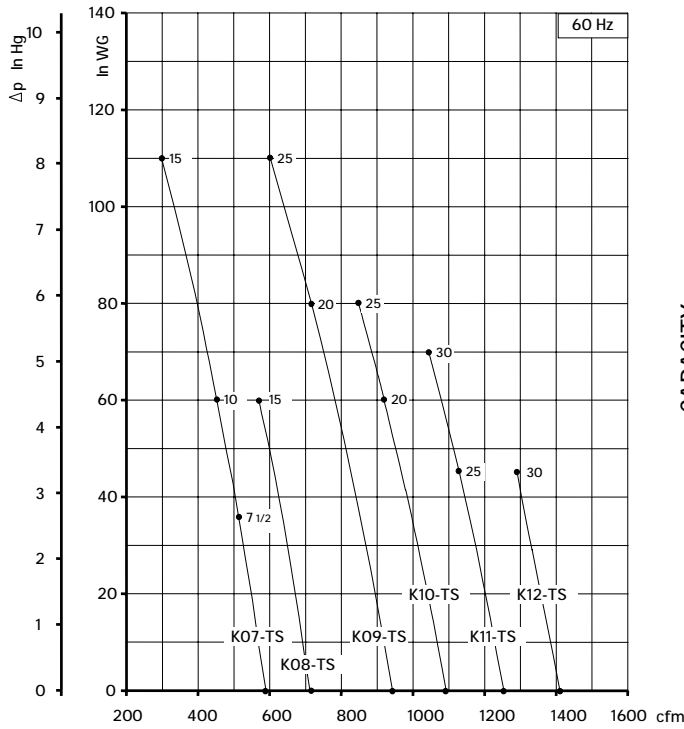

Curves refer to air at 68° F temperature, measured at inlet port and 29.92 In Hg atmospheric backpressure (abs).
Values for flow, power consumption and temperature rise: +/-10% tolerance.
Data subject to change without notice.