



TECHNICAL CHARACTERISTICS

- Aluminium alloy construction
- Smooth operation
- High efficiency impeller
- Maintenance free
- Mountable in any position
- Recognized TEFC - cURus motor
- G1/8" female thread on both suction and discharge silencer port flanges

OPTIONS

- Special voltages (IEC 38)
- Surface treatments

ACCESSORIES

- Inlet and/or inline filters
- Additional inlet/outlet silencers
- Safety valves
- Flow converting device
- Optional connectors

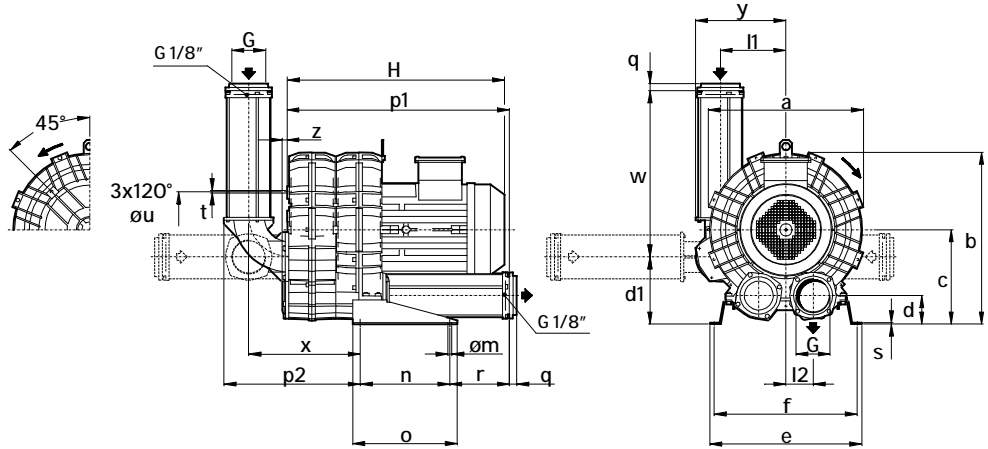

Dimensions in inches.
Dimension for reference only.

Model	a	b	c	d	d1	e	f	G	l1	l2	m	n	o	p1	p2	q	r	s	t	u	w	x	y	z
K07-TD	16.69	18.94	10.59	3.23	7.56	18.43	17.24	3"NPT	7.36	3.05	0.51	11.81	13.78	25.55	15.43	0.98	5.39	0.20	M8	11.61	18.94	12.56	10.24	0.63
K08-TD	17.99	19.61	10.59	3.23	7.56	18.82	17.64	3"NPT	7.36	3.05	0.51	11.81	13.78	25.55	15.43	0.98	5.39	0.20	M8	12.20	18.94	12.56	10.24	0.63
K09-TD	19.37	22.09	12.4	3.78	8.86	20.0	18.82	4"NPT	8.66	3.58	0.51	11.81	13.78	29.33	17.91	0.98	7.83	0.20	M8	14.17	21.89	14.65	11.89	0.63
K10-TD	20.31	22.56	12.4	3.78	8.86	20.0	8.82	4"NPT	8.66	3.58	0.51	11.81	13.78	29.33	17.91	0.98	7.83	0.20	M8	14.17	21.89	14.65	11.89	0.63
K11 -TD	21.26	23.70	13.07	3.54	9.13	21.18	20.0	4"NPT	9.53	3.94	0.51	11.81	13.78	30.12	18.50	0.98	8.03	0.20	M8	15.35	21.89	15.24	12.76	0.63
K12-TD	21.57	23.81	13.07	3.54	9.13	21.18	20.0	4"NPT	9.53	3.94	0.51	11.81	13.78	30.23	18.50	0.98	8.03	0.20	M8	15.35	21.89	15.24	12.76	0.63

Model	Maximum flow cfm		Installed power Hp		Maximum differential pressure Δp (In Hg)		Noise level Lp dB (A) ⁽¹⁾		Overall dimensions H Inches	Weight Lbs
	60 Hz 3500 rpm	50 Hz 2900 rpm	60 Hz 3500 rpm	50 Hz 2900 rpm	60 Hz 3500 rpm	50 Hz 2900 rpm	60 Hz 3500 rpm	50 Hz 2900 rpm		
	K07-TD	296	245	15	15	12.6	11.8	79.5	77.5	24.5
K08-TD	368	305	15	15	12.6	12.6	79.9	77.9	24.5	248.5
K09-TD	467	387	25	-	14.0	13.3	82.8	-	30.0	406.0
K10-TD	571	473	25	25	13.3	13.3	86.5	84.5	30.0	412.0
K11-TD	642	532	25	25	9.6	12.6	87.2	85.2	30.5	442.0
K12-TD	716	593	30	30	8.9	12.6	88.0	86.0	31.0	443.0

(1) Noise measured at 1 m distance with inlet and outlet ports piped, in accordance to ISO 3744.

- For proper use, the blower should be equipped with inlet filter and safety valve; other accessories available on request.
- Ambient temperature from +5° to +104°F.
- Specifications subject to change without notice.



SCL K07 / K08 / K09 / K10 / K11 / K12
TD SERIES

SN 1834-12B 2/2

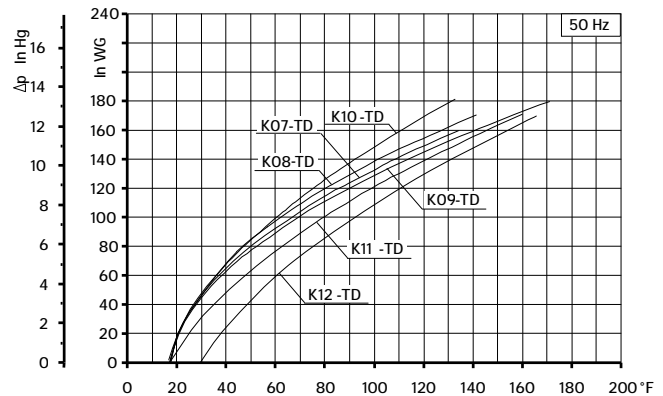
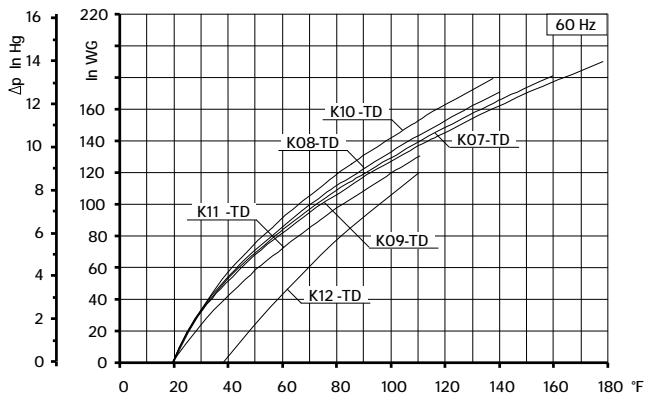
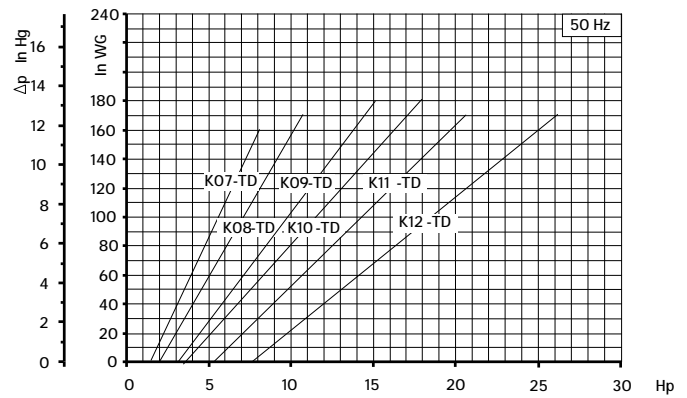
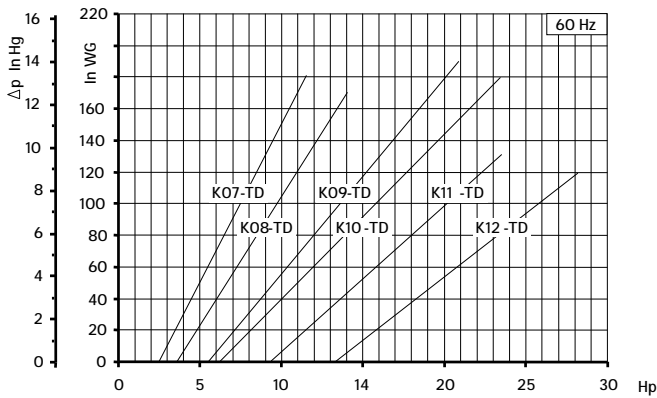
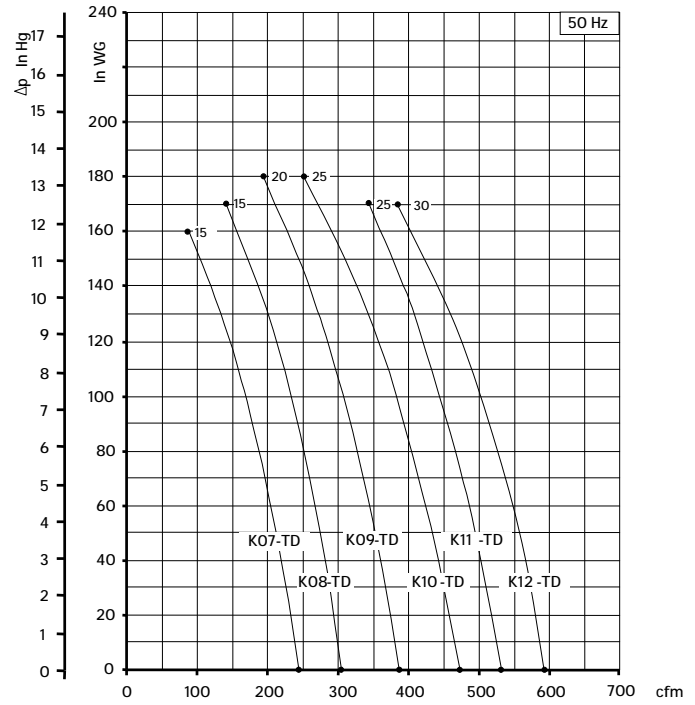
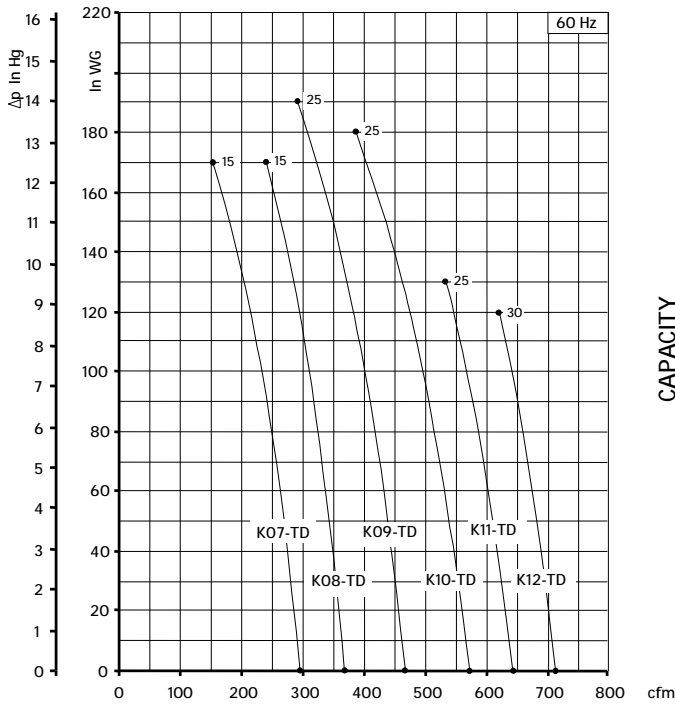

Curves refer to air at 68°F temperature, measured at inlet port and 29.92 In Hg atmospheric backpressure (abs).
Values for flow, power consumption and temperature rise +/-10% tolerance.
Data subject to change without notice.