

# INSTRUCTION MANUAL FOR LINEAR COMPRESSORS

MODEL

EL-60  
EL-80-15  
EL-80-17  
EL-100

EL-120W  
EL-150  
EL-200

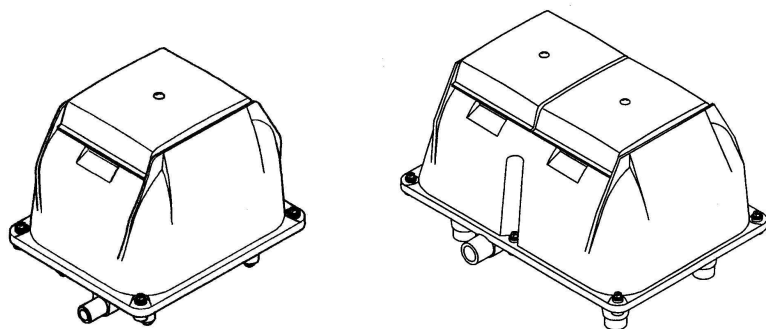

READ AND FOLLOW ALL SAFETY INSTRUCTIONS.  
KEEP THIS MANUAL FOR FUTURE REFERENCE.

 SECOH SANGYO CO.,LTD.  
世晃産業株式会社

## CONTENTS

1. Parts name .....	2
2. Instructions	
2-1 Prior to operation .....	3
2-2 Storage and transfer.....	3
2-3 Installation .....	4
1) Location .....	4
2) Grounding .....	5
3) Mounting .....	5
4) Plumbing .....	6
5) Operation .....	6
3. Periodical maintenance	
3-1 Filter element cleaning .....	7
3-2 Replacement of filter element, .....	7
valve box, diaphragm	
3-3 Reset of auto stopper .....	9
3-4 Automatically reset thermal protector.....	9
4. Trouble shooting .....	10
5. Replacement parts .....	10
6. Specifications .....	11

## 1. Parts name

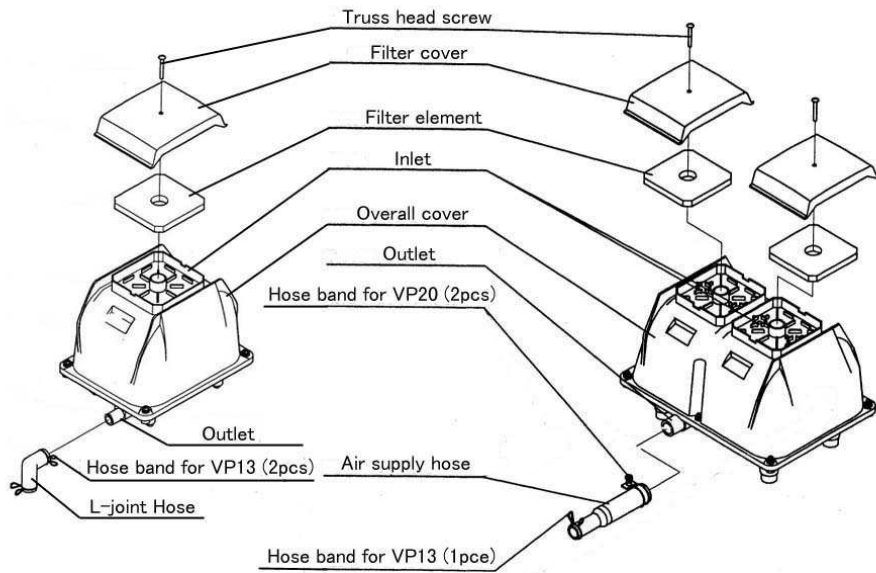

EL-60, 80-15, 80-17, 100

EL-120W, 150, 200

## 2. Instructions

- Read information carefully to ensure that this product operates correctly.
- Follow the safety instructions.
- Any servicing other than that recommended in this manual should be performed by an authorized service facility.

The following is an explanation of the three different types of hazards.

- ⚠ **DANGER** Severe personal injury or death will occur if hazard is ignored.
- ⚠ **WARNING** Severe personal injury or death can occur if hazard is ignored.
- ⚠ **CAUTION** Minor injury or property damage can occur if hazard is ignored.

### 2-1. Prior to operation

#### ⚠ **WARNING**

- This product is designed for air only.
  - To reduce the risk of ignition, electric shock or short circuit, do not pump flammable gas or liquid. Pumped fluid passes through the live parts.
- Connect this product to the specified power supply voltage specified on the name plate to avoid electric shock or short circuit.
- Close supervision is necessary when any appliance is used by or near children.

- This product is not designed for mounting on a vehicle.

### 2-2. Storage and transfer

#### ⚠ **WARNING**

- Carry this product by both hands.
  - Do not carry this product by holding filter cover. The body which may slip from the filter cover can cause injury.
  - To avoid damage on wire do not carry this product by holding the power supply cord.
- Pump surfaces can get very hot during operation. Do not touch those surfaces until they cool.

- Do not store this product in temperatures below 14° F ( -10°C ). Failure to do so could result in malfunction due to magnet deterioration.
- Store this product indoors out of the weather to avoid rubber parts deterioration.

### 2-3. Installation

#### ⚠ **WARNING**

- Installation of this product including wiring and plumbing should be done by our distributor or specialist.
- Carefully examine the pump after installation. It should not be plugged in if there is water on parts not intended to be wet.

### 1) Location

#### ⚠ **WARNING**

- To avoid short circuit or electric shock do not install this product in an area where it could be immersed in water or other liquids.
- Install this product above the water level to ensure no siphoning can occur if power should fail. Failure to do so will result in short circuit or electric shock by run back liquid into this product.

#### ⚠ **DANGER**

- To avoid ignition do not install this product in an area where it could come in contact with flammable or explosive gas.

- Install this product in the shade and well ventilated place.
  - The heat of sunlight may shorten diaphragm and valve life due to very high temperature.
- Do not install this product in humid or dusty area.
  - Overheating caused by clogged filter may result in shortening diaphragm and valve life.
- Install this product in an area where working space for maintenance can be secured.

### 2) Grounding

#### ⚠ **DANGER**

- Improper installation of the grounding plug can result in a risk of electric shock. If repair or replacement of the cord or plug is necessary, do not connect the grounding wire to either flat blade terminal. The wire with insulation having an outer surface that is green, with or without yellow stripes, is the grounding wire.

- This product should be grounded. In the event of an electrical short circuit, grounding reduces the risk of electric shock by providing an escape wire for the electric current. This product is equipped with an electric cord having an equipment grounding conductor and a grounding type plug. The plug must be plugged into an outlet that is properly installed and grounded in accordance with all appropriate codes and ordinances.
- This product is for use on a nominal 120V volt circuit, and has a grounding plug. Make sure that the product is connected to an outlet having the same configuration as the plug as follows. No adapter should be used with the product.

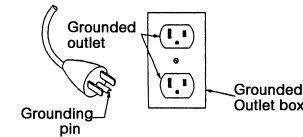

- Use only 3-wire outdoor use extension cord that has a 3-blade grounding plug, and a 3 slot receptacle that will accept the plug on the product. Make sure your extension cord is in good condition. When using an extension cord, be sure to use one heavy enough to carry the current your product will draw. For lengths less than 50 feet , 16AWG extension cords should be used. An undersized cord will cause a drop in line voltage resulting in loss of power and overheating. The extension cord should be marked " for outdoor use".

### 3) Mounting

#### ⚠ **WARNING**

- This product must be weather protected to avoid risk of electric shock or short circuit if it is mounted in an area exposed to water or other liquids
- Ensure this product is securely mounted prior to operation.

**CAUTION**

- The ambient temperature should not be over 104° F (40°C).
- Cooling fan is recommended to be installed when mounting in an area of higher temperature.

- This product should be mounted on horizontal, stable and rigid surface for appropriate operation.

**4) Plumbing**

- Connect the pumps exhaust port and rigid plastic pipe VP13 ( ID 13mm x OD 18mm ) with an L-joint hose.
- Plumbing with smaller diameter pipe may be the cause of excess pressure and overheat which will shorten the diaphragm and valve life.
- Be sure to secure place of connection with hose band (Ref: Fig 1).
- Do not get the L-joint hose twisted.
- The length of plumbing should be as short and straight as possible.
- If its length is over 16.4ft. ( 5m ), consult our distributor.
- Make sure that nothing remains in the pipe during plumbing.
- If foreign material is left, it may be the cause of excess pressure and overheat which will shorten the diaphragm and valve life.

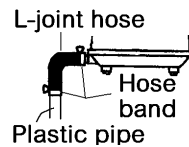

Fig. 1

**DANGER**

- To avoid the risk of fire or electric shock do not modify, heat or pull the power cord.
- Do not put heavy load on the power cord. The power cord may be damaged, if hazard is ignored.
- Clean electric source plug connectors once a year and plug in securely.
- Dust on source plug connectors or improper plugging can cause fire or electric shock.

**WARNING**

- Do not touch the electric source plug with wet hands.
- Grasp plug to remove power cord from outlet. Do not remove by pulling on power cord.
- Do not operate if the cord or plug is damaged, or if this product is malfunctioning, dropped, or damaged in anyway.

**3. Periodical maintenance**

**WARNING**

- Always disconnect power before servicing. Failure to do so could result in electrical shock, personal injury or death.

**CAUTION**

- Clean the filter element quarterly. A clogged filter element can cause overheating or pump failure.

**3-1 Filter element cleaning**

- Undo the truss head screw.
- Remove the filter cover (Ref: Fig 2-A.)
- Take out the filter element and slap down dust by hand. (Ref: Fig 2-B)
- If it is heavily clogged, wash it by rubbing using neutral detergent. Wash with water and dry it in the shade.
- Reassemble the filter element back in place and press in the filter cover.
- Fix the filter cover by the truss head screw.

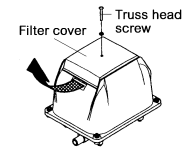

Fig 2-A

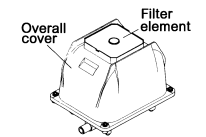

Fig 2-B

**3-2 Replacement of filter element, valve box, diaphragm**

- Replace filter element following the procedure in 3-1 Filter element cleaning.
- Undo the four corner bolts and remove the overall cover. In case the overall cover is hard to remove, insert a slotted screw driver in (A). (Ref: Fig 2-C)
- Remove the shock absorber. Undo the screws (B) and remove the holder cover. ( Ref: Fig 2-D)
- Undo the screws (C)and remove the valve box of one side, pinching the hose band (Ref: Fig 2-E).
- Insert magnet support jig in four corners between the magnet and the core as below. (Ref: Fig 2-F, G)

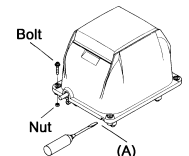

Fig 2-C

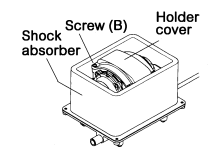

Fig 2-D

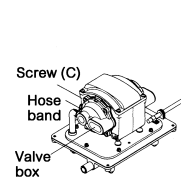

Fig 2-E

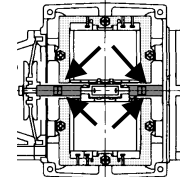

Fig 2-F

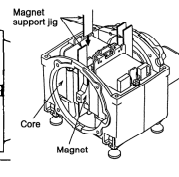

Fig. 2-G

- Undo (D) and remove diaphragm holder and diaphragm. (Ref: Fig 2-H)

Note:

(D) of EL-60, EL-80-15, EL-120W: Nut

(D) of EL-80-17, EL-100, EL-150, EL-200 : Bolt

- Set new diaphragm holder and diaphragm to the magnet and fix them by (D). (Ref: Fig 2-H)

Note:

Use new nut or bolt (D) in the repair kit.

Note the locating notch for reassembly. (Ref:Fig.2-I)

- Set new valve box and fix it by four corner screws (C)

- Replace the valve box, diaphragm holder and diaphragm of the other side in the same way.

- Pull out the magnet support jig. (Ref:Fig.2-F,G)

- Make sure that clearance between the magnet and the solenoid of both sides is even.

- Connect the exhaust port with the connecting pipe and tighten it by the hose band securely. (Ref:Fig.2-E)

- Reset the auto-stopper, if necessary. (Ref:3-3 Reset of auto-stopper.

- Connect power and confirm the operation.

- Fix the holder cover by four corner screws (B).

- Put the shock absorber. (Ref: Fig.2-D)

- Put the overall cover, inserting the power cord rubber bush into the location notch of the overall cover. (Ref:Fig.2-J).

- Fix the overall cover securely by nuts and bolts.

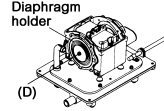

Fig 2-H

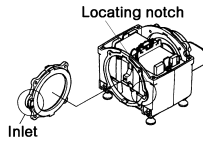

Fig 2-I

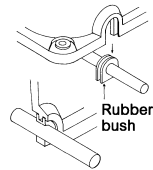

Fig 2-J

**WARNING**

- If the magnet contacts the solenoids during operation, it will cause damage on parts, abnormal heat, short circuit.

**DANGER**

- Do not touch the live parts. Touching the live parts will result in electric shock.

**CAUTION**

- Improper setting of the rubber bush can result in electric shock, airleakage.

**DANGER**

- Disconnect power before servicing.  
Do not touch the terminal of the switch. If hazard is ignored, electric shock is possible.  
If not disconnected, magnet starts moving upon reset of auto stopper.  
Personal injury is possible.

**3-3 Reset of auto stopper**

If the diaphragm is broken, the magnet reciprocates with abnormal amplitude and the projection hits the slider.

The contact is interrupted and power is off.  
( Ref: Fig. 3-A )

- Insert a slotted screw driver and push the slider.
- Set the slider at the position L1=L2.  
( Ref: Fig. 3-B )

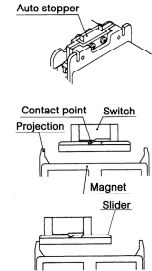

Fig. 3-A

**3-4 Automatically reset thermal protector**

An automatically reset thermal protector installed on the solenoid stops pump operation if solenoid temperature becomes over  $130 \pm 5$  °C. When the solenoid temperature cools down to  $120 \pm 5$  °C, the protector is reset automatically and pump operation restarts.

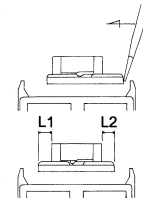

Fig. 3-B

#### 4. Trouble shooting

Observation	Possible cause	Action
Pump does not operate.	<ul style="list-style-type: none"> <li>Improper electrical connection</li> <li>Auto-stopper activated</li> </ul>	<ul style="list-style-type: none"> <li>Check plug and outlet and plug completely.</li> <li>Replace diaphragm and reset auto-stopper</li> </ul>
Discharge air decreased.  Pump surface is abnormally hot.  Pump operates intermittently	<ul style="list-style-type: none"> <li>Pipe or diffuser clogged</li> <li>Valve in plumbing shut</li> <li>Filter element clogged</li> </ul>	<ul style="list-style-type: none"> <li>Clean pipe or diffuser.</li> <li>Open the valve</li> <li>Clean filter element.</li> </ul>
Pump operates but with abnormal noise.	<ul style="list-style-type: none"> <li>Faulty valve or diaphragm</li> </ul>	<ul style="list-style-type: none"> <li>Replace valve and diaphragm.</li> </ul>

#### 5. Replacement parts

Kit name	Contained parts	Quantity (pcs)
Diaphragm repair kit for EL-60, 80-15, 80-17, 100	Diaphragm	2
	Diaphragm holder	2
	Nut or bolt	2
	Valve box	2
	Filter element	1
Diaphragm repair kit for EL-120W, 150, 200	Diaphragm	4
	Diaphragm holder	4
	Nut or bolt	4
	Valve box	4
	Filter element	2

#### 6. Specifications

Model	EL-60	EL-80-15	EL-80-17	EL-100
<b>Voltage</b>	V	110/115		
<b>Frequency</b>	Hz	50/60		
<b>Rated pressure</b>	psi (kPa)	2.13 (14.7)		2.42 (16.7)
<b>Rated air flow</b>	LPM	62/64	80/80	85/95 105/115
<b>Amperage</b>	Amp.	1.6	2.6	1.8 2.5
<b>Bore diameter</b>	mm	OD:19 ID:11		
<b>Net weight</b>	lbs. (kg)	18.7 ( 8.5 )		
<b>Accessory</b>		L-joint hose		

Model	EL-120W	EL-150	EL-200
<b>Voltage</b>	V	110/115	
<b>Frequency</b>	Hz	50/60	
<b>Rated pressure</b>	psi (kPa)	2.85 (19.6)	
<b>Rated air flow</b>	LPM	130/150	155/175 195/220
<b>Amperage</b>	Amp.	3.8	3.2 4.0
<b>Bore diameter</b>	mm	OD:27 ID:15	
<b>Net weight</b>	lbs. (kg)	35.2 (16.0)	
<b>Accessory</b>		Air supply hose	

The information presented in the specification table is based on technical and test results of nominal units. It is believed to be accurate and is offered as an aid in the selection of the products. It is the user's responsibility to determine suitability of the product for intended use and the user assumes all risk and liability whatsoever in connection therewith. Environmental and application conditions may affect advertised life.

**DISTRIBUTED BY**

**MANUFACTURED BY**



Head Office:

966 Ogo, Tabuse-cho, Kumage-gun, Yamaguchi-pref. 742-1513 Japan  
TEL: +81-820-52-2147 FAX: +81-820-52-2148