



**Evolution Series
Technical Characteristics**

- Premium efficient motor
- High efficiency impeller
- Mountable in any position
- Maintenance free operation
- TEFC (IP55)

Optional Features

- Anodized aluminum components for corrosion resistance
- Increased sealing

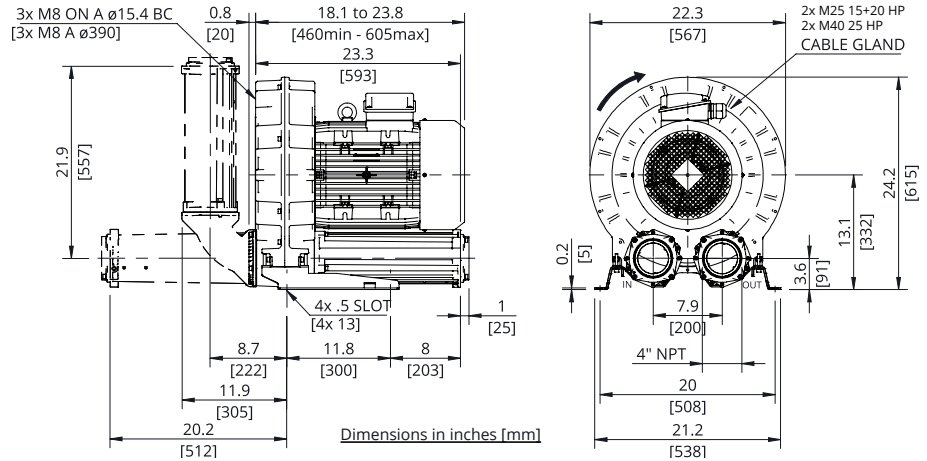

Technical Specifications

Model No.	HP	Hz	Open Flow (cfm)	Max Pressure in. H ₂ O	Max Vacuum in. H ₂ O	Efficiency	Voltage	FLA	Starting Current Ratio ¹	dB(A) ²	Weight (lb)
SCL e11-MS-15-3	15	60	639	80	90	91.0%	208-230/460	38.2-37.3/18.7	12.5	83	248.0
		50	553	110	120	91.0%	200/400	43.4/21.7		78	
SCL e11-MS-15-3-575	15	60	639	80	90	91.0%	575	13.9	11	83	248.0
SCL e11-MS-20-3	20	60	639	120	150	91.7%	208-230/460	47.0 / 23.5	9.7	83	273.4
		50	553	160	140	91.9%	200/400	52.4 / 26.2		78	
SCL e11-MS-20-3-575	20	60	639	120	150	91.0%	575	18.8	9.8	83	273.4
SCL e11-MS-25-3	25	60	639	150	-	91.7%	208-230/460	62 / 31	12.5	83	352.7
		50	553	180	-	92.4%	200/400	69 / 34.5		78	
SCL e11-MS-25-3-575	25	60	639	150	-	91.7%	575	24.8	12.5	83	352.7

Motors include normally closed thermal protector, 1.15 S.F. (60 Hz), tropicalized windings, Class F (B) insulation, and are suitable for use with a VFD (Contact FPZ for pneumatic and speed limits when used with a VFD).

¹Starting current ratio x fla = starting current

²Noise level measured at a distance of 1 m with inlet and outlet ports piped in accordance to ISO 3744

Data is subject to change without notice.

Recommended Accessories

Description	Pressure Safety Valve	Vacuum Safety Valve	Pressure Filter	Vacuum Filter	Check Valve
Part Number	VRL9 (15 HP) ³	VRL9 (15 HP) ³	FS-245P-400	CSL-2541-400I	CV40
	VRL8 (20 HP & 25 HP) ³	VRL8 (20 HP) ³			

³Valve selections are based on 60 Hz and standard air. Valves are supplied uncalibrated. Safety valves are easy to calibrate, but can be ordered with factory calibration.



PRESSURE

VACUUM

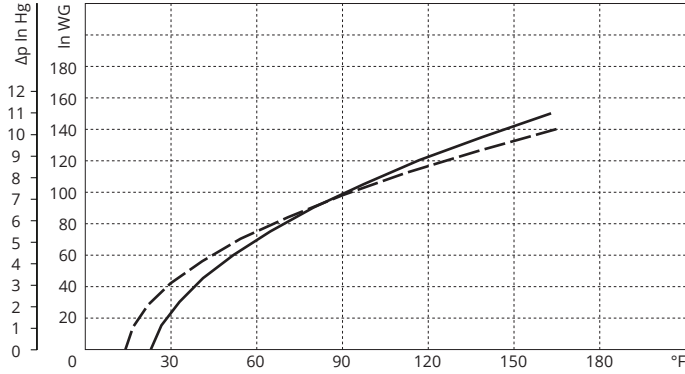
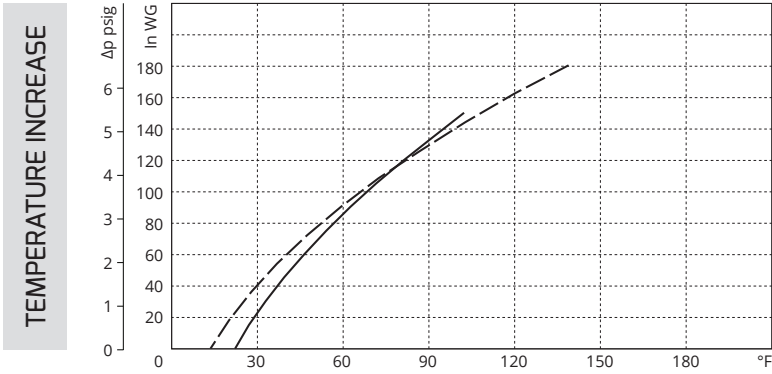
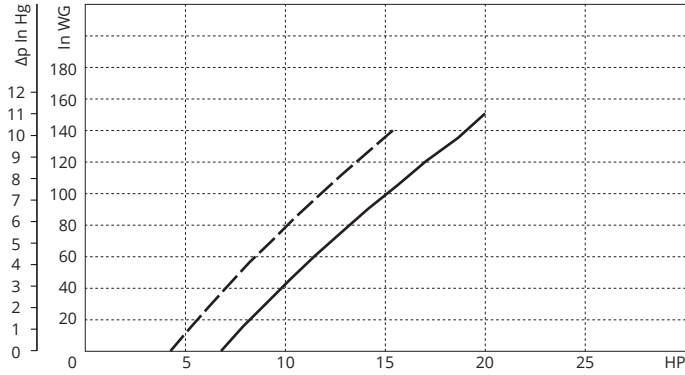
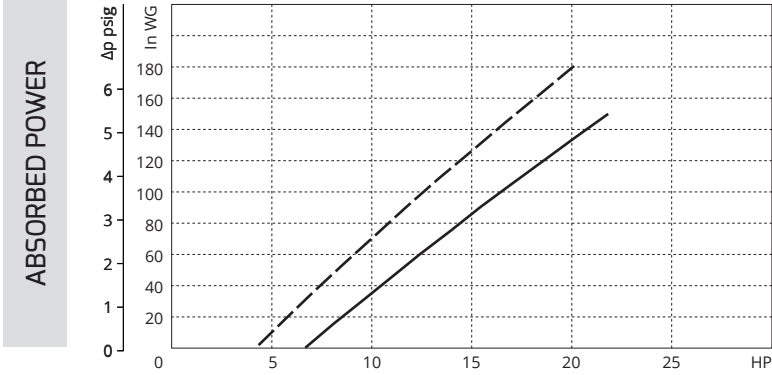
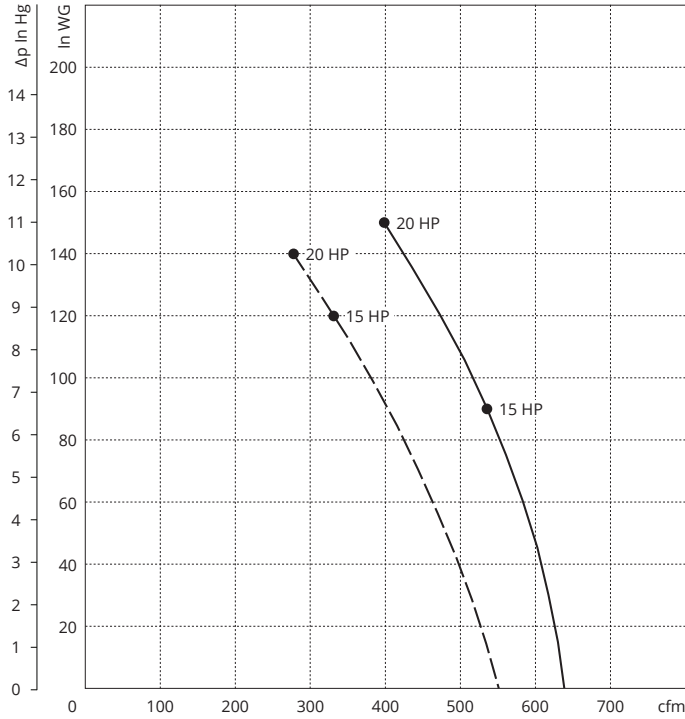
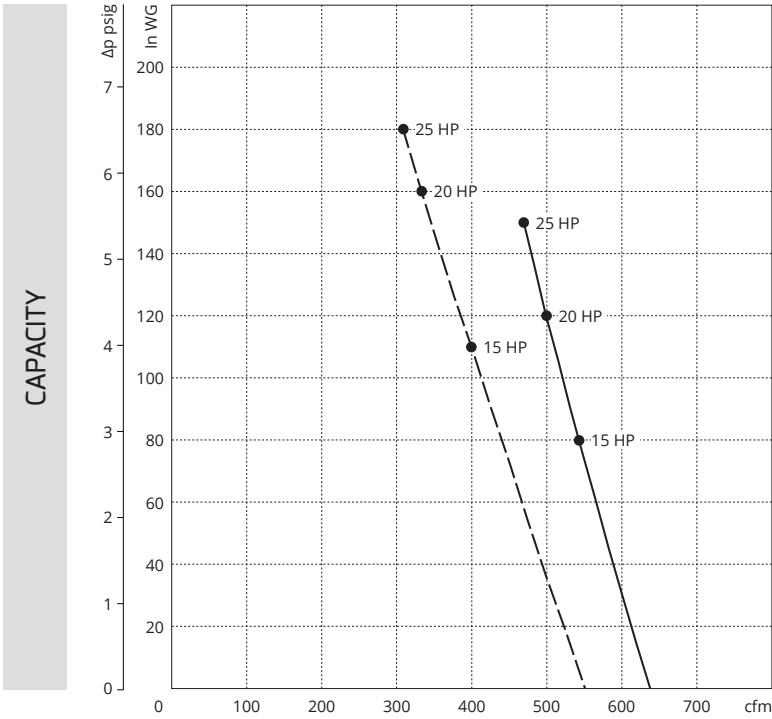

Curves refer to air at 68°F temperature and 29.92 In Hg atmospheric pressure (abs) measured at inlet port.
 Values for flow, power consumption and temperature rise: +/-10% tolerance.
 Data subject to change without notice.

KEY --- 50 Hz
 — 60 Hz