



**Evolution Series
Technical Characteristics**

- Premium efficient motor
- High efficiency impeller
- Mountable in any position
- Maintenance free operation
- TEFC (IP55)

Optional Features

- Anodized aluminum components for corrosion resistance
- Increased sealing

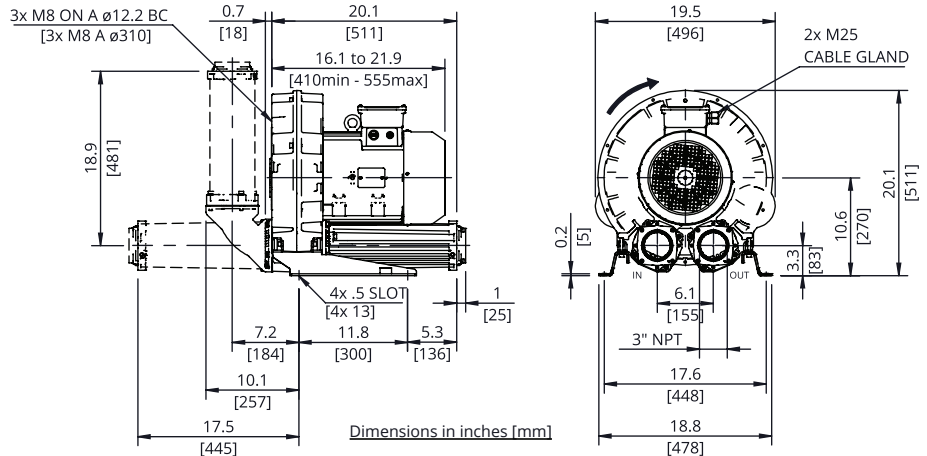

Technical Specifications

| Model No. | HP | Hz | Open Flow (cfm) | Max Pressure in. H ₂ O | Max Vacuum in. H ₂ O | Efficiency | Voltage | FLA | Starting Current Ratio ¹ | dB(A) ² | Weight (lb) |
|----------------------|-----|----|-----------------|-----------------------------------|---------------------------------|------------|-------------|----------------|-------------------------------------|--------------------|-------------|
| SCL e08-MS-5.5-3 | 5.5 | 60 | 394 | 40 | 40 | 88.5% | 208-230/460 | 14.6-15.1/7.55 | 11.1 | 76.8 | 143.3 |
| | | 50 | 331 | 70 | 70 | 88.1% | 200/400 | 17.7/8.86 | | 72.1 | |
| SCL e08-MS-5.5-3-575 | 5.5 | 60 | 394 | 40 | 40 | 88.5% | 575 | 5.31 | 10.9 | 76.8 | 143.3 |
| SCL e08-MS-7.5-3 | 7.5 | 60 | 394 | 70 | 80 | 89.5% | 208-230/460 | 19.8-19.5/9.75 | 13.7 | 76.8 | 167.6 |
| | | 50 | 331 | 110 | 110 | 89.2% | 200/400 | 22.2/11.1 | | 72.1 | |
| SCL e08-MS-7.5-3-575 | 7.5 | 60 | 394 | 70 | 80 | 89.5% | 575 | 7.21 | 13.5 | 76.8 | 167.6 |
| SCL e08-MS-10-3 | 10 | 60 | 394 | 110 | 110 | 90.2% | 208-230/460 | 26.1-25/12.5 | 13 | 76.8 | 194.0 |
| | | 50 | 331 | 150 | 120 | 90.1% | 200/400 | 28.6/14.3 | | 72.1 | |
| SCL e08-MS-10-3-575 | 10 | 60 | 394 | 110 | 110 | 90.2% | 575 | 10 | 12.9 | 76.8 | 194.0 |
| SCL e08-MS-15-3 | 15 | 60 | 394 | 170 | 130 | 91.0% | 208-230/460 | 38.2-37.3/18.7 | 12.5 | 76.8 | 207.3 |
| | | 50 | 331 | 170 | 120 | 91.0% | 200/400 | 43.4 / 21.7 | | 72.1 | |
| SCL e08-MS-15-3-575 | 15 | 60 | 394 | 170 | 130 | 91.0% | 575 | 13.9 | 11 | 76.8 | 207.3 |

Motors include normally closed thermal protector, 1.15 S.F. (60 Hz), tropicalized windings, Class F (B) insulation, and are suitable for use with a VFD (Contact FPZ for pneumatic and speed limits when used with a VFD).

¹Starting current ratio x fla = starting current

²Noise level measured at a distance of 1 m with inlet and outlet ports piped in accordance to ISO 3744

Data is subject to change without notice.

Recommended Accessories

| Description | Pressure Safety Valve | Vacuum Safety Valve | Pressure Filter | Vacuum Filter | Check Valve |
|-------------|-------------------------------------|---------------------|-----------------|---------------|-------------|
| Part Number | VRL6 (10 HP & 15 HP) ³ | VRL6 (15 HP) | FS-235P-300 | CT-235P-300C | CV30 |
| | VRL8 (5.5 HP & 7.5 HP) ³ | VRL8 (5.5 HP-10 HP) | | | |

³Valve selections are based on 60 Hz and standard air. Valves are supplied uncalibrated. Safety valves are easy to calibrate, but can be ordered with factory calibration.



PRESSURE

VACUUM

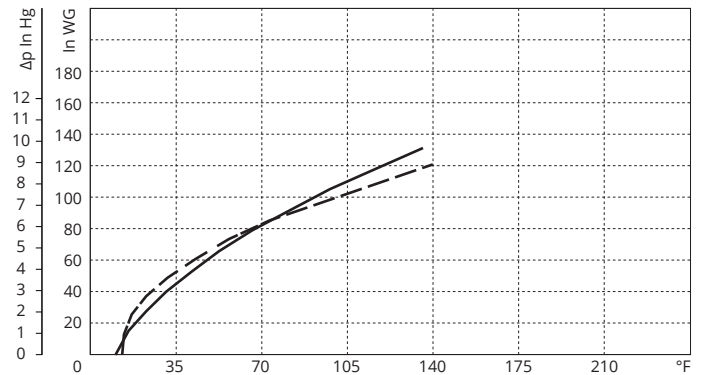
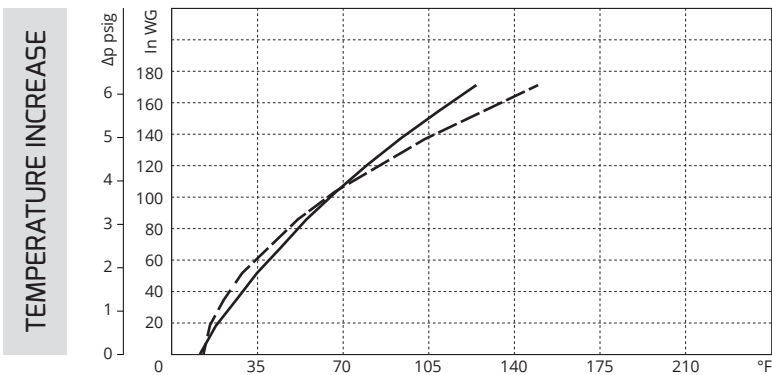
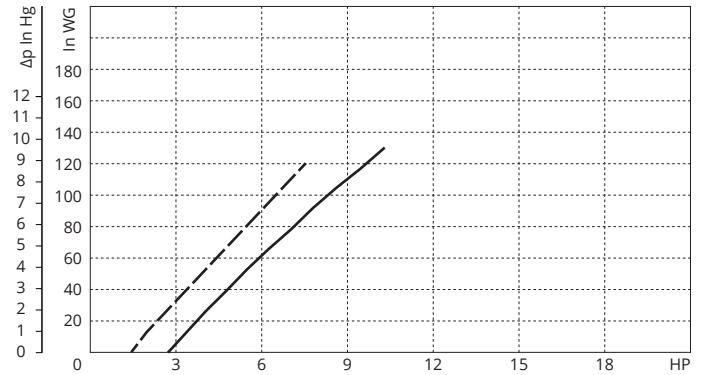
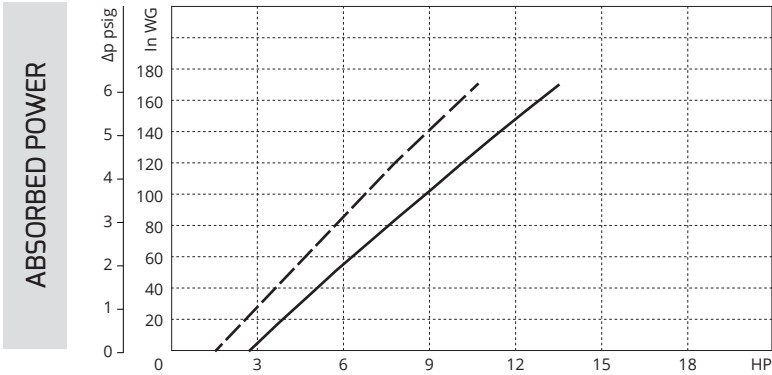
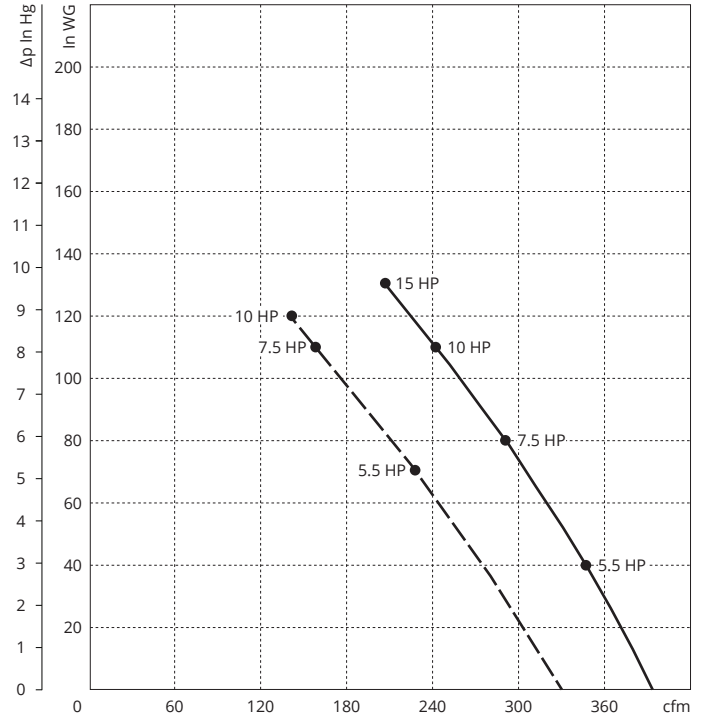
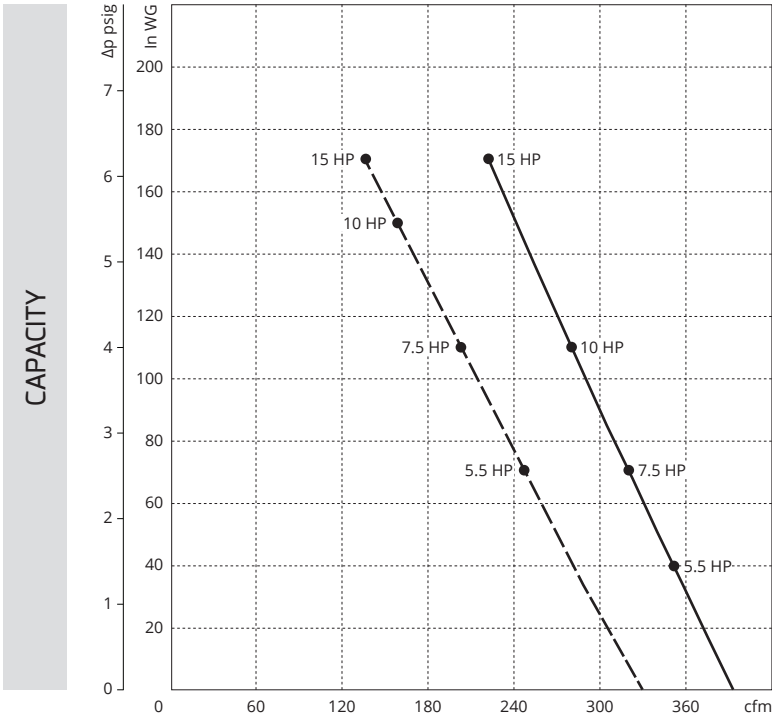

Curves refer to air at 68°F temperature and 29.92 In Hg atmospheric pressure (abs) measured at inlet port.
 Values for flow, power consumption and temperature rise: +/-10% tolerance.
 Data subject to change without notice.

KEY --- 50 Hz
 — 60 Hz