



e12-MD

**Evolution Series
Technical Characteristics**

- Premium efficient motor
- High efficiency impeller
- Mountable in any position
- Maintenance free operation
- TEFC (IP55)

Optional Features

- Anodized aluminum components for corrosion resistance
- Increased sealing

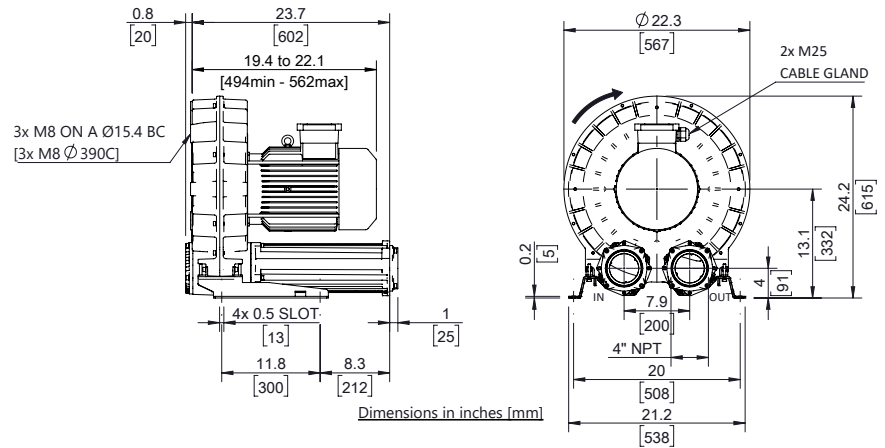

Technical Specifications

Model No.	HP	Hz	Open Flow (cfm)	Max Pressure in. H ₂ O	Max Vacuum in. H ₂ O	Efficiency	Voltage	FLA	Starting Current Ratio ¹	dB(A) ²	Weight (lb)
SCL e12-MD-15-3	15	60	367	140	170	91.0%	208-230/460	38.2-37.3/18.7	12.5	80	248.1
		50	307	220	170	91.0%	200/400	43.4 / 21.7		77	248.1
SCL e12-MD-15-3-575	15	60	367	140	180	91.0%	575	13.9	11	80	248.1
SCL e12-MD-20-3	20	60	367	240	-	91.7%	208-230/460	47.0 / 23.5	9.7	80	271.2
		50	307	260	-	91.9%	200/400	52.4 / 26.2		77	271.2
SCL e12-MD-20-3-575	20	60	367	240	-	91.0%	575	18.8	9.8	80	271.2

Motors include normally closed thermal protector, 1.15 S.F. (60 Hz), tropicalized windings, Class F (B) insulation, and are suitable for use with a VFD (Contact FPZ for pneumatic and speed limits when used with a VFD).

¹Starting current ratio x fla = starting current

²Noise level measured at a distance of 1 m with inlet and outlet ports piped in accordance to ISO 3744

Data is subject to change without notice.

Recommended Accessories

Description	Pressure Safety Valve	Vacuum Safety Valve	Pressure Filter	Vacuum Filter	Check Valve
Part number	VRL6 ³	VRL6 ³	FS-235P-400	CT-235P-400C	CV40

³Valve selections are based on 60 Hz and standard air. Valves are supplied uncalibrated. Safety valves are easy to calibrate, but can be ordered with factory calibration.



PRESSURE

VACUUM

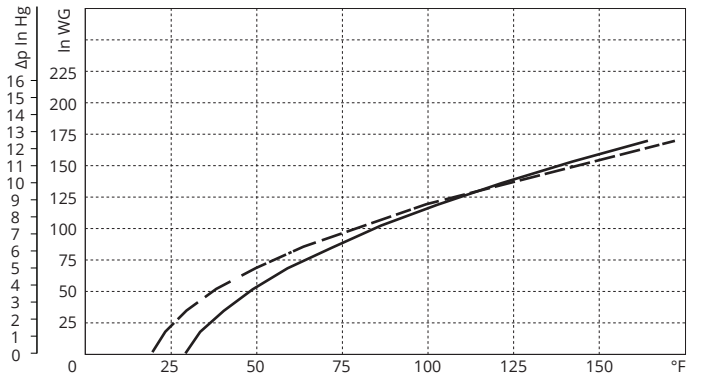
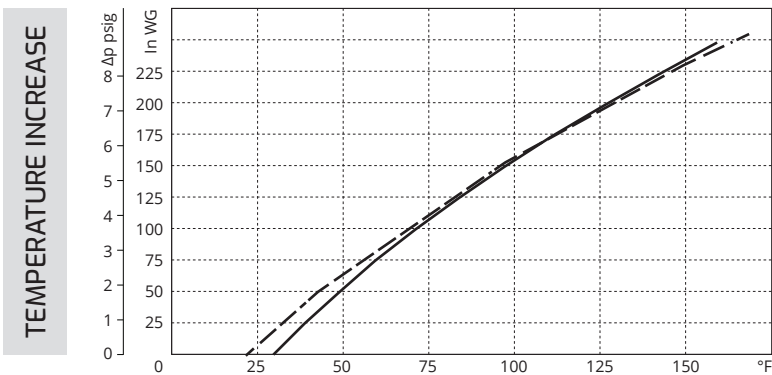
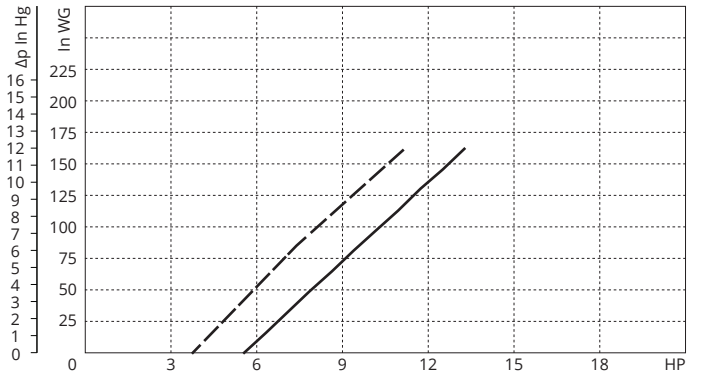
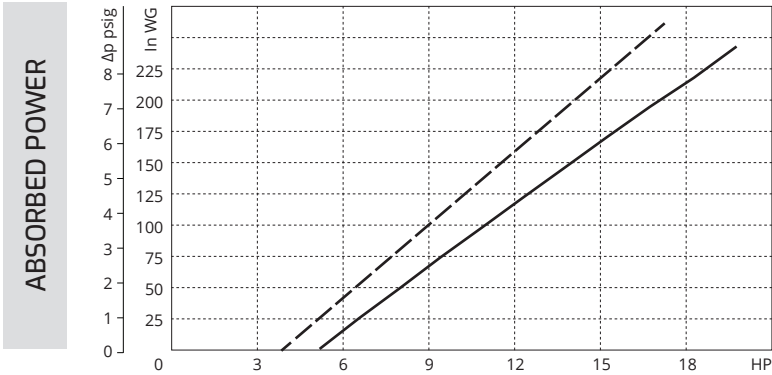
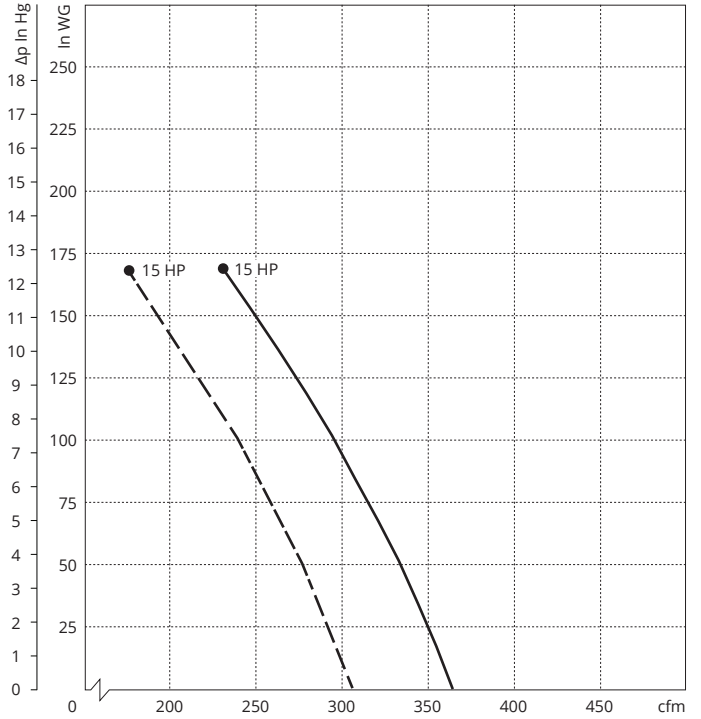
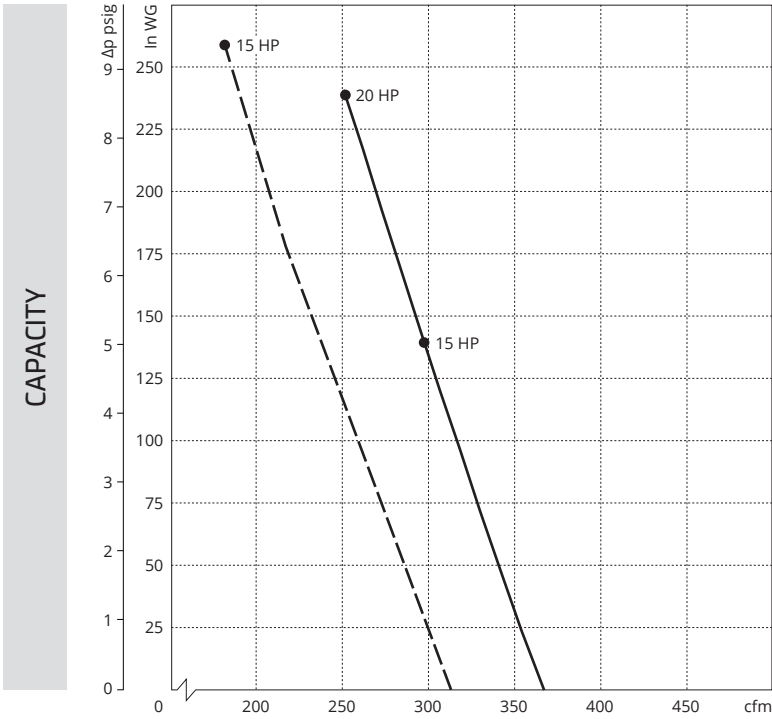

Curves refer to air at 68°F temperature and 29.92 In Hg atmospheric pressure (abs) measured at inlet port.
Values for flow, power consumption and temperature rise: +/-10% tolerance.
Data subject to change without notice.

KEY --- 50 Hz
 — 60 Hz